



## KURUMSAL TANITIM



## Hakkımızda

Temelleri 2013 yılında kurulan Poligon Mühendislik ile atılan **PLG Grup** çatısı altında; **Poligon Mühendislik**, **PLG Labs** ve **PLG Engineering** firmaları yer almaktadır.

PLG Grup, fikir aşamasından seri üretime kadar tüm ürün geliştirme çalışmalarını kendi bünyesinde çözebilecek güçlü bir altyapıya sahiptir. **HP** ve **Scanology** gibi dünyaca ünlü teknoloji markalarının Türkiye Yetkili Temsilcisi olan grup; sahip olduğu bu yetkinlikler ve yüksek teknoloji ile piyasaya ürün çıkarma konusunda müşterilerine en hızlı şekilde, en uygun maliyetle, en doğru çözümü sunmaktadır.



**PLG Grup ile  
Yarına Liderlik  
Etmeye Hazır Ol!**



# PLG Grup Yapısı

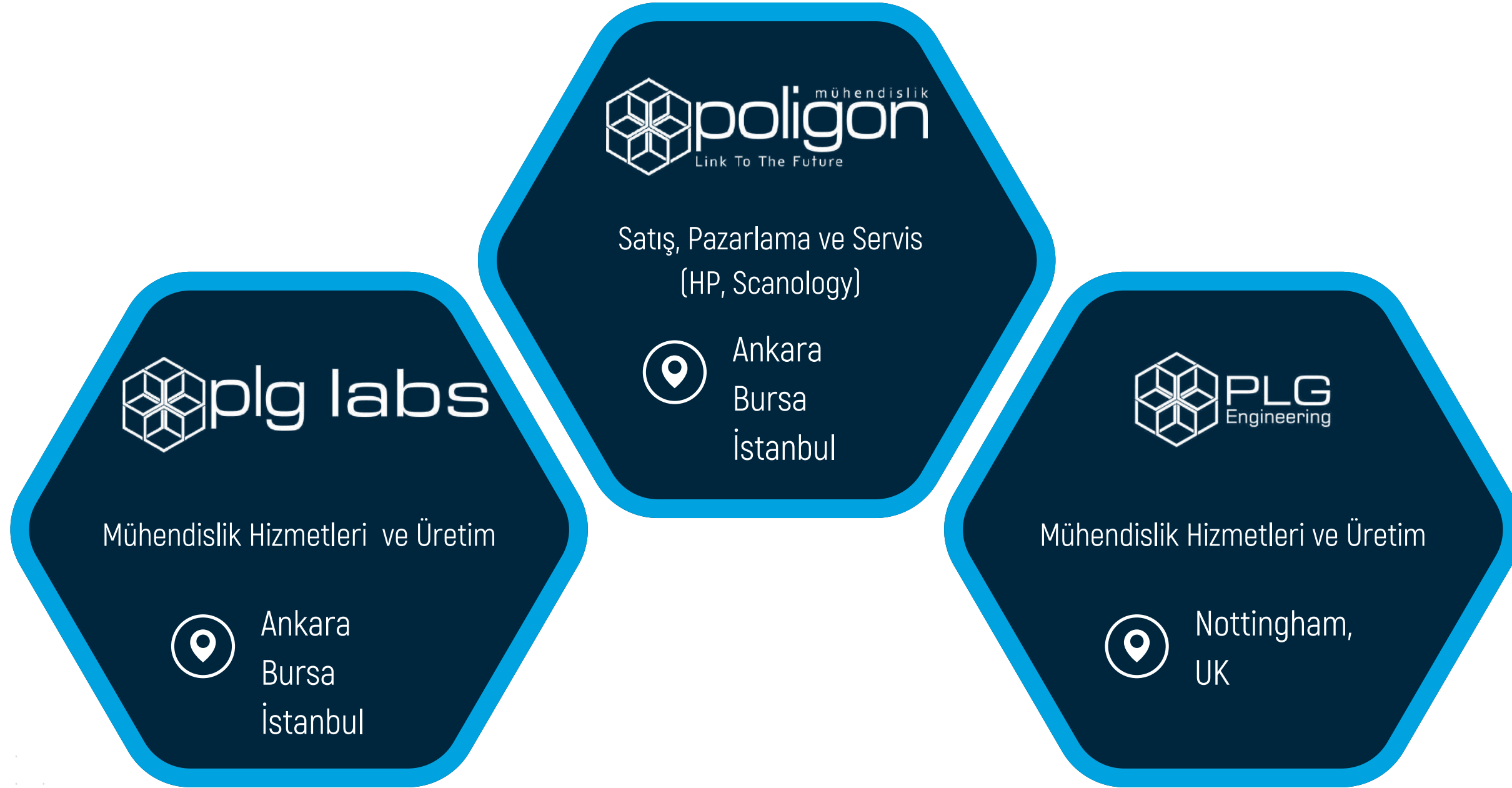

**+500.000**  
SAAT  
3D BASKI DENEYİMİ



**+25.000**

SAAT  
TERSİNE MÜHENDİSLİK  
DENEYİMİ



**2 SEÇKİN**

GLOBAL PARTNER  
HP, Scanology

**4 LOKASYONDA**

**2.000 m<sup>2</sup>** KAPALI ALAN

Ankara & İstanbul & Bursa & Nottingham



**ÇÖZÜM ODAKLI**

MÜHENDİSLİK YAKLAŞIMI



**GÜVENİLİR**

MARKA İMAJI



**MÜKEMMEL**

MÜŞTERİ DENEYİMİ

**7/24**

MÜŞTERİ ÖNCELİĞİ



**SERTİFİKALI KALİTE**

ISO 9001: 2015

AS 9100 REV. D

EYDEP, JOSCAR, TUSAS

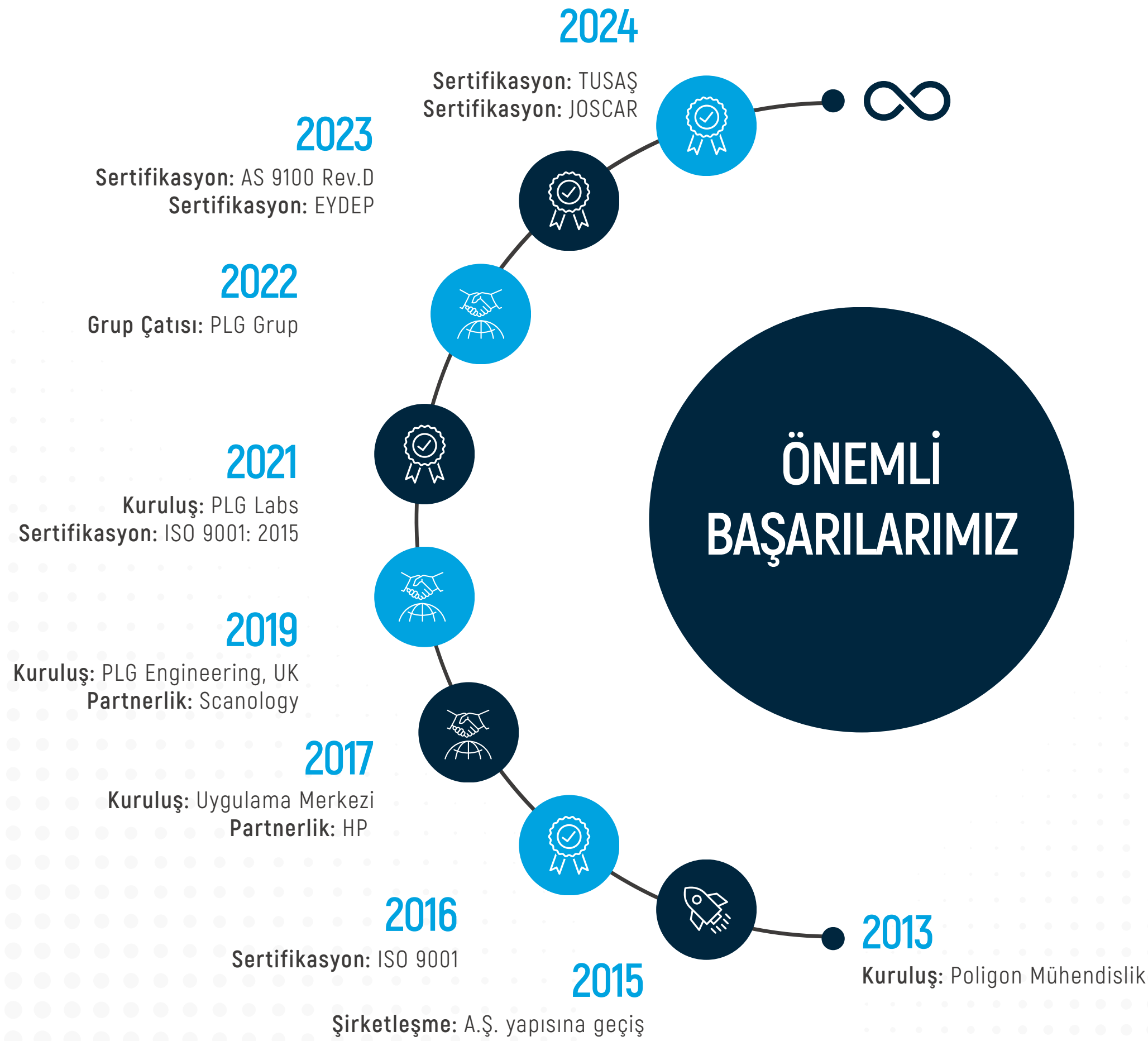

# Kalite Belgeleri & Sertifikalarımız



ISO 9001: 2015



AS 9100 Rev. D



EYDEP



TUSAŞ



JOSCAR

# Bize Güvenen İş Ortaklarımız



aselsan

BAYKAR



BRUSA



farplas



fkt



TRM TRMOTOR GÜÇ SİSTEMLERİ



LUCID



MARTURFOMPAK INTERNATIONAL



B/S/H/

Ferre

Haier



odelo: Automotive Signal Lights

OYAK RENAULT OTOMOBİL FABRİKALARI



simfer

VESTEL



TOFAŞ TÜRK OTOMOBİL FABRİKASI A.Ş.



## Ürünlerimiz

HP 3D Yazıcılar  
Scantech 3D  
Tarayıcılar

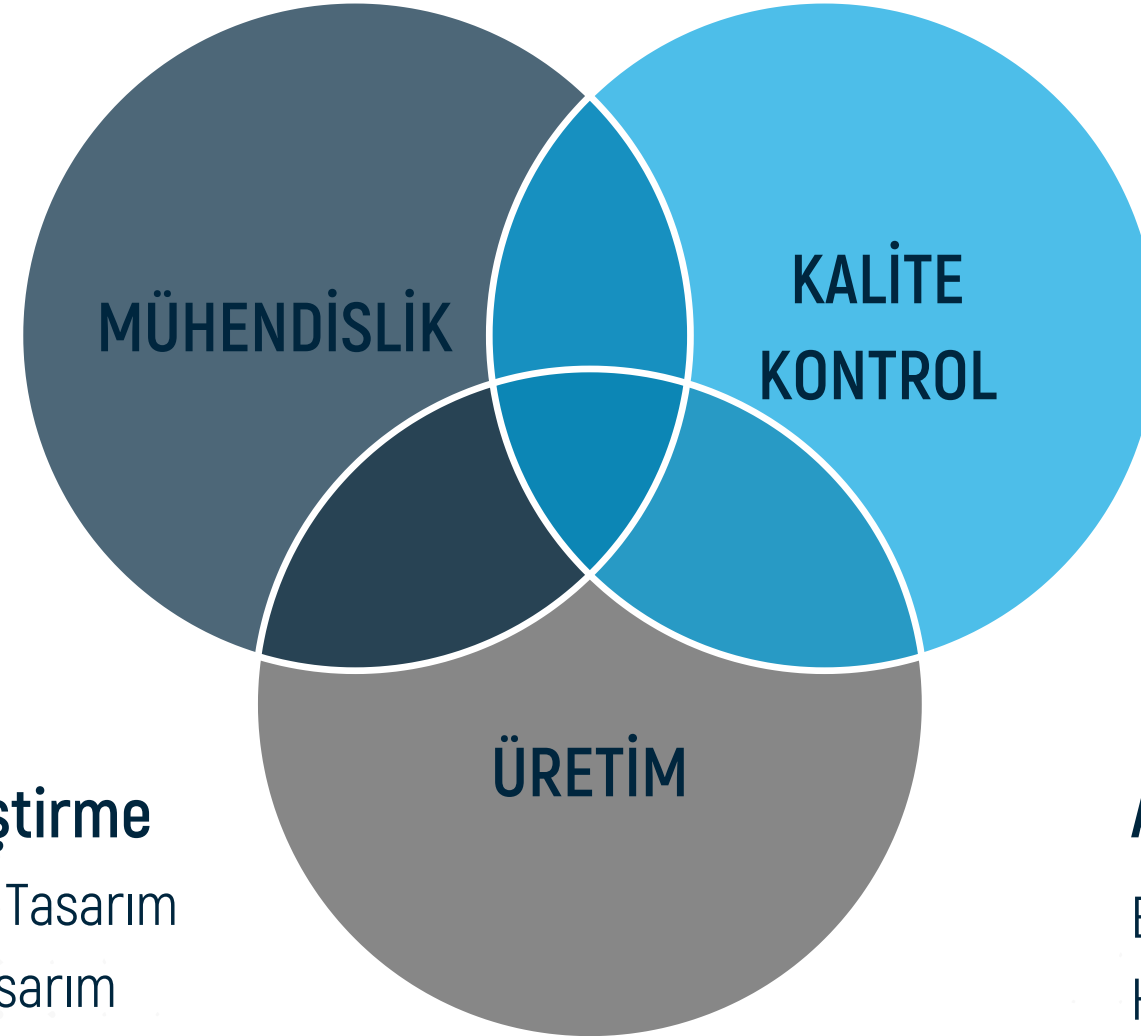

## Kalite Kontrol

3D Tarama  
Kalite Kontrol  
Raporlama  
Data Optimizasyonu  
Catia v5 CAD Modelleme

## Ürün Geliştirme

Endüstriyel Tasarım  
Mekanik Tasarım  
Tersine Mühendislik  
Analiz & Simülasyon  
Tesislerin Dijital İkizi

## Az Adetli İmalat

Eklemeli İmalat  
Hızlı Prototipleme  
Hızlı Kalıplama  
Talaşlı İmalat - CNC  
Ardıl İşlem

# Çalışma Alanlarımız

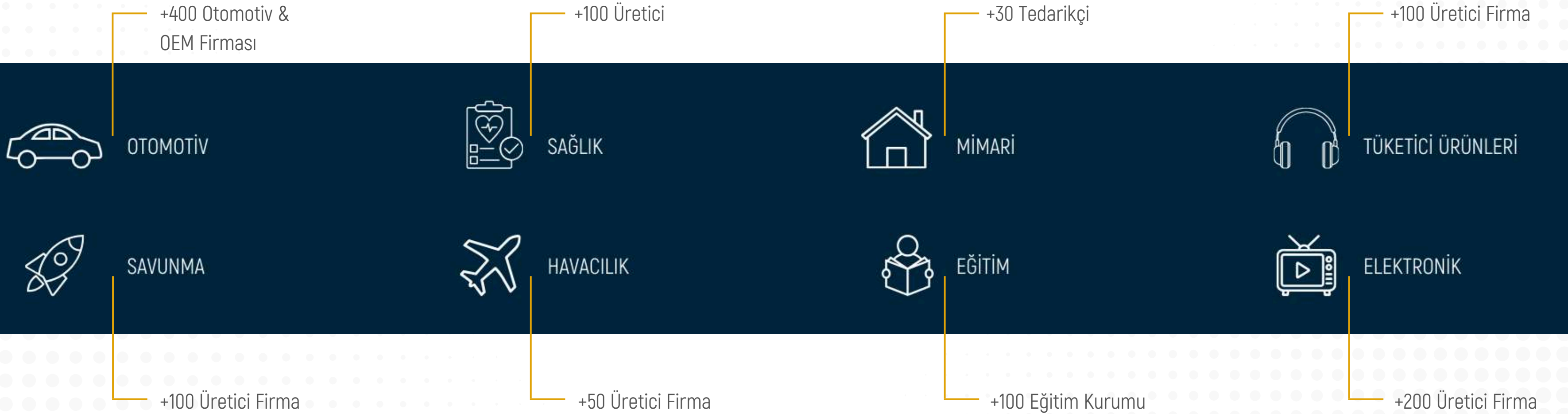

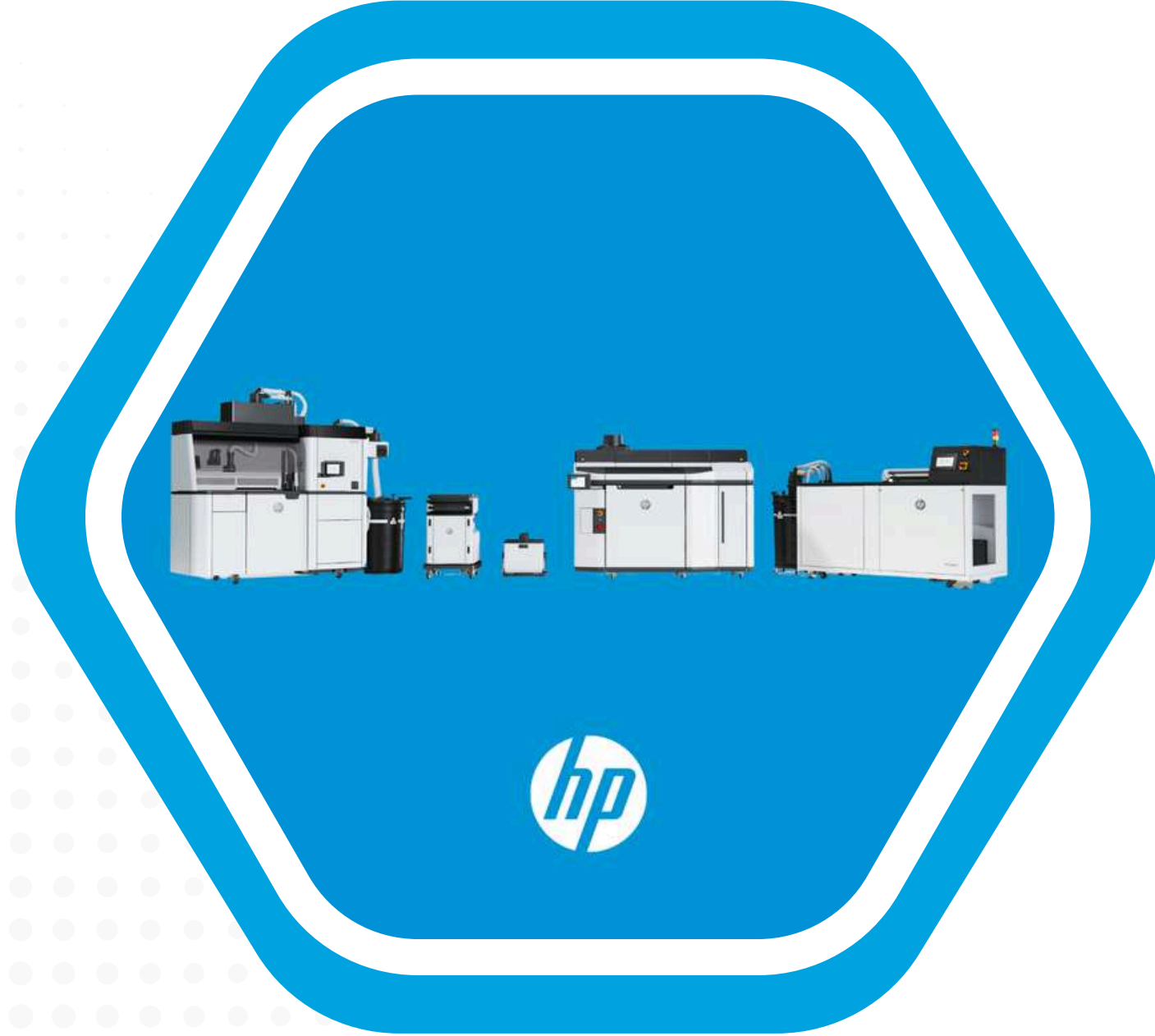

HP Jet Fusion Endüstriyel 3D Baskı Çözümleri



3B Lazer Tarama Sistemleri

Kalite Kontrol Yazılımları

## Eklemeli İmalat



**Makine:** HP Jet Fusion 5620  
**Üretim Hacmi:** 380x284x380mm



**Makine:** HP Jet Fusion 4200  
**Üretim Hacmi:** 380x284x380mm

Yıllık 4 milyon cm<sup>3</sup> üretim hacmi ile Türkiye'nin en büyük HP Multi Jet Fusion (MJF) üretim kapasitesi

## Talaşlı İmalat - CNC



**Makine:** 3 eksen CNC  
**İşleme Hacmi:** 1060x600x560mm

## Hızlı Kalıplama



**Makine:** Vakum PU Döküm Makinesi  
**Döküm Kapasitesi:** 1,5 kg



**Makine:** RIM PU Döküm Makinesi  
**Döküm Kapasitesi:** 3,5 kg

## Yazılım

SolidCAM  
SolidWorks  
CatiaV5  
GeomagicsDesignX  
GeomagicsControlX  
PolyWorks  
Magics RP  
GrabCAD  
Z-Suit  
AutoDeskNetFabb

# Başarı Hikayelerimiz - Otomotiv



OTOMOTİV



SAĞLIK



MİMARİ



TÜKETİCİ ÜRÜNLERİ



SAVUNMA



HAVACILIK



EĞİTİM



ELEKTRONİK

## Fonksiyonel Prototip İmalatı

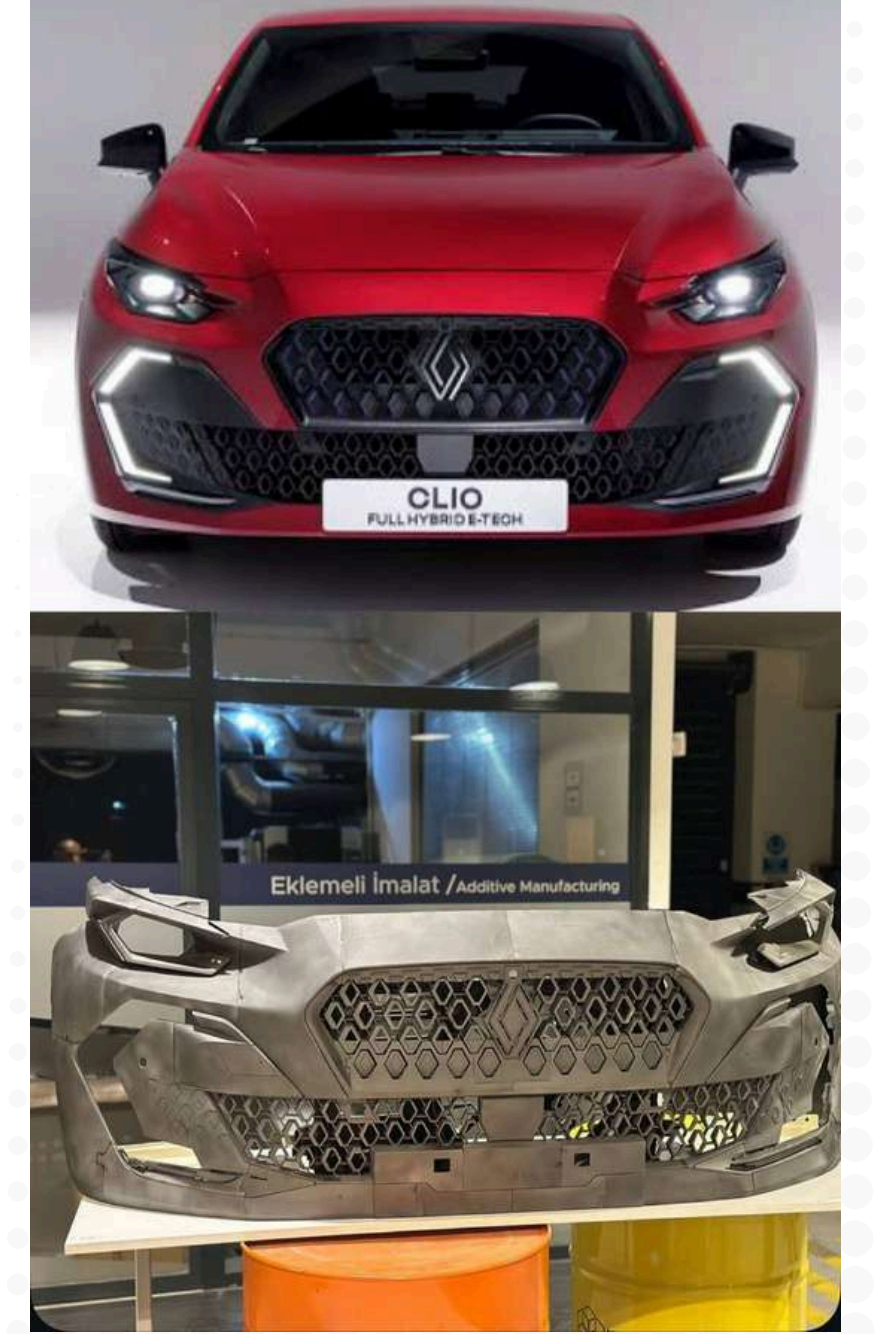

- DFAM çalışması
- Fikstür tasarım ve imalatı
- Birleştirme teknoloji seçimi
- Yüzey İşlem ve Boya

RENAULT Clio 6

## F-Max Aksesuar Parçaları

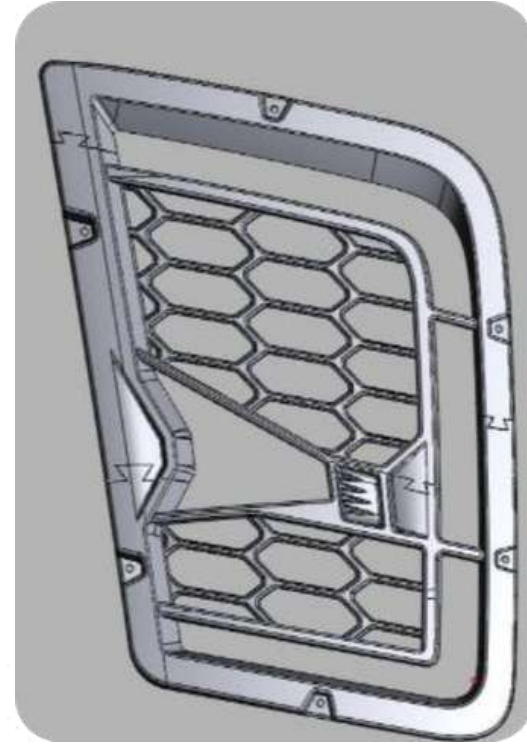

- Gerçek malzeme ile üretim
- Yüzey İşlem
- Krom kaplama
- Yerinde montaj desteği
- 9 günde üretim

- 3D tasarım
- DFAM çalışması
- Parçalı Üretim için özel kesim teknikleri
- Eklemeli İmalat ile üretim
- Yüzey İşlem ve Boya
- Teslim Süresi: 36 saat



FORD

## Mock-Up Çalışması



- DFAM çalışması
- Parçalı Üretim için özel kesim teknikleri
- Eklemeli İmalat ile üretim
- Ardıl İşlem ve Boya
- 1:4 Ölçek

TOGG

## Az Adetli Son Kullanım Parçalar



- Silikon Kalıplama ile üretim
- Fonksiyonel parçalar
- 180 adet üretim
- Yüzey işlem ve boya
- 18 hafta süre kazancı
- €40K kalıp tasarrufu

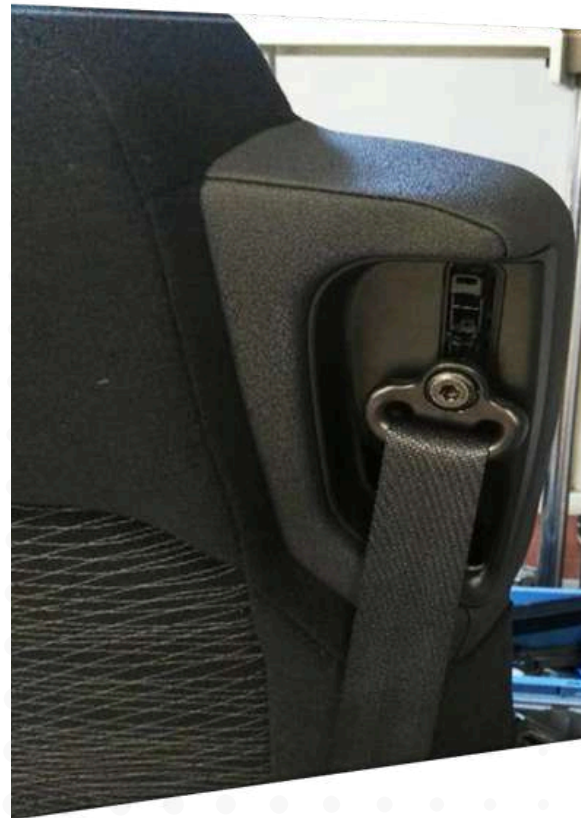

- Prototip Kalıp İmalatı
- Enjeksiyon kalıbı öncesi fonksiyonel test parçaları
- Tekrarlanabilir hassasiyet
- 200 adet parça üretimi
- Serigrafi ve yüzey işlemleri
- Teslimat süresi 7-10 iş günü
- 24 hafta proje takviminden tasarruf

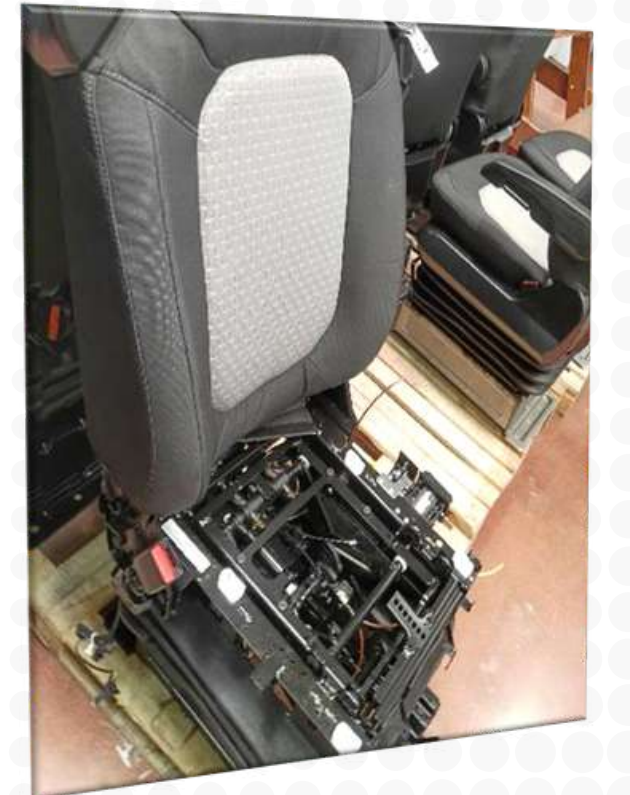

# Başarı Hikayelerimiz - Savunma



OTOMOTİV



SAĞLIK



MİMARİ



TÜKETİCİ ÜRÜNLERİ



SAVUNMA



HAVACILIK



EĞİTİM



ELEKTRONİK

## Az Adetli Fonksiyonel Prototip

- 3D Tarama
- Tersine Mühendislik
- Modüler Tasarım
- DFAM
- Orijinali ile aynı ağırlık ve ağırlık merkezi
- Kırılmaz
- Yüzey işlem ve boya
- 20 adet üretim

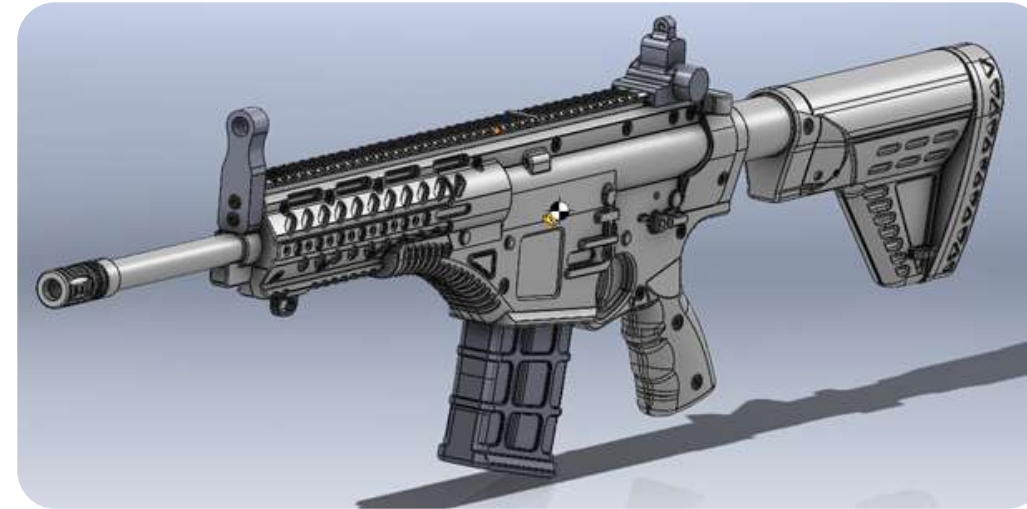

ÜRGE Projesi: Havelan-MPT76-Eğitim Tüfeği

# Başarı Hikayelerimiz - Havacılık



OTOMOTİV



SAĞLIK



MİMARİ



TÜKETİCİ ÜRÜNLERİ



SAVUNMA



HAVACILIK



EĞİTİM



ELEKTRONİK

## Fonksiyonel Prototip

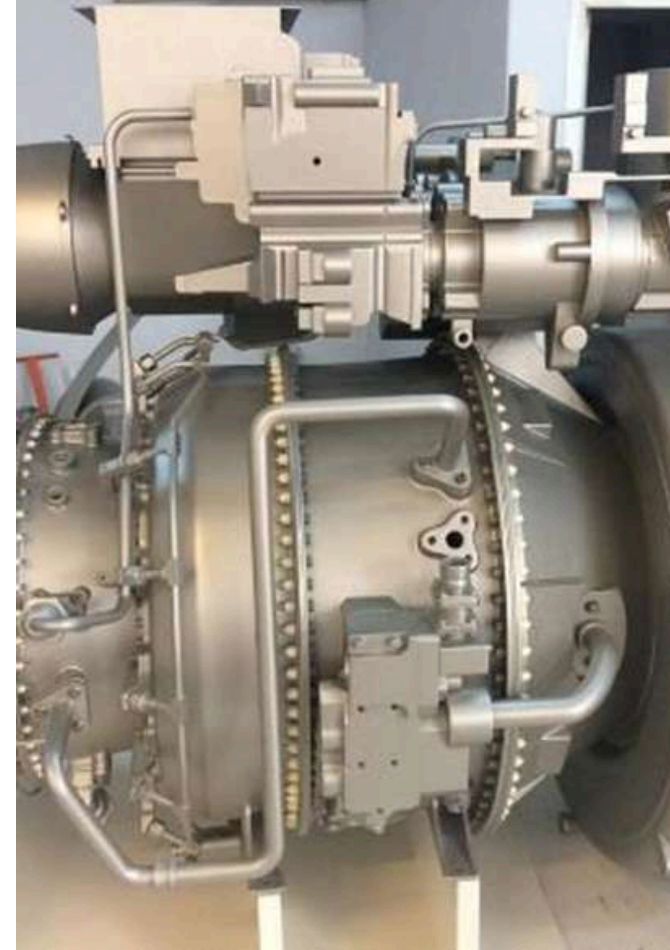

- DFAM
- Eklemeli İmalat ile üretim
- Yüzey işlem ve boya
- Montaj

## TEİ - Fonksiyonel Turbo Şaft Motoru Mock-Up

## Mock-Up Çalışması

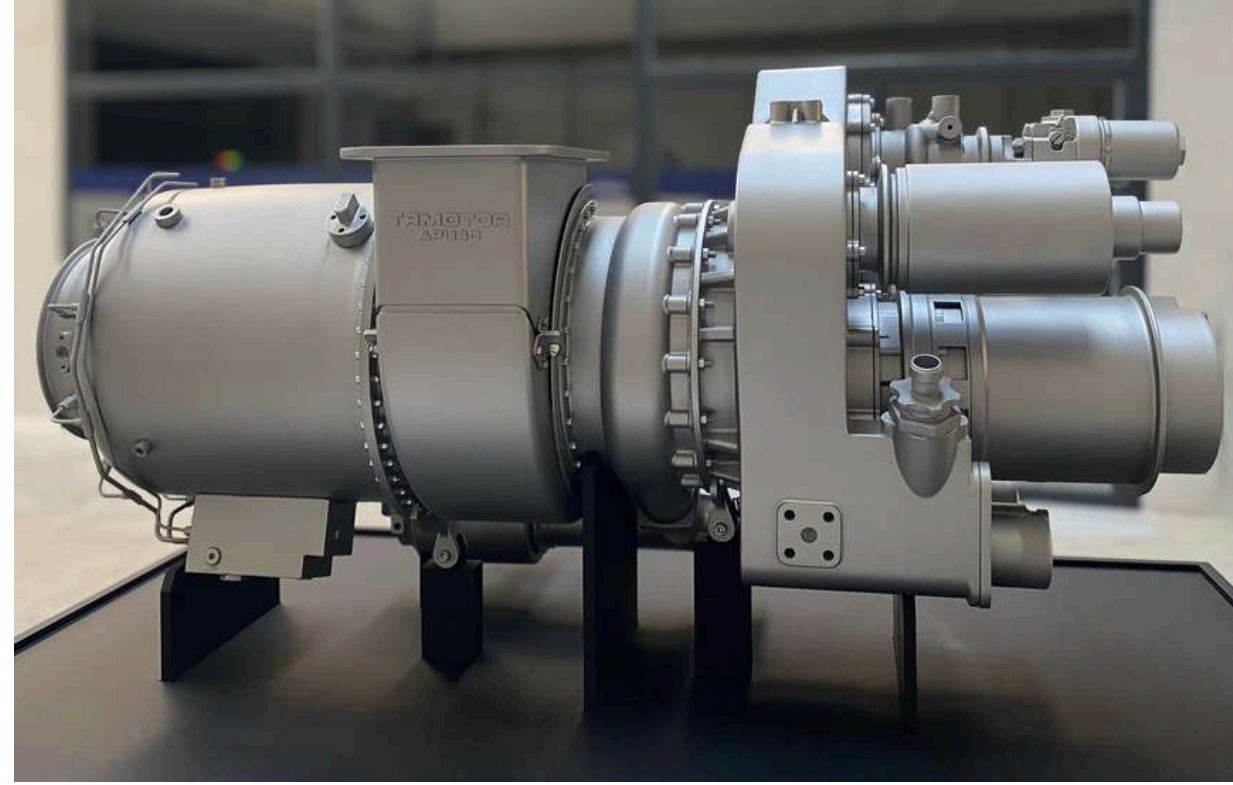
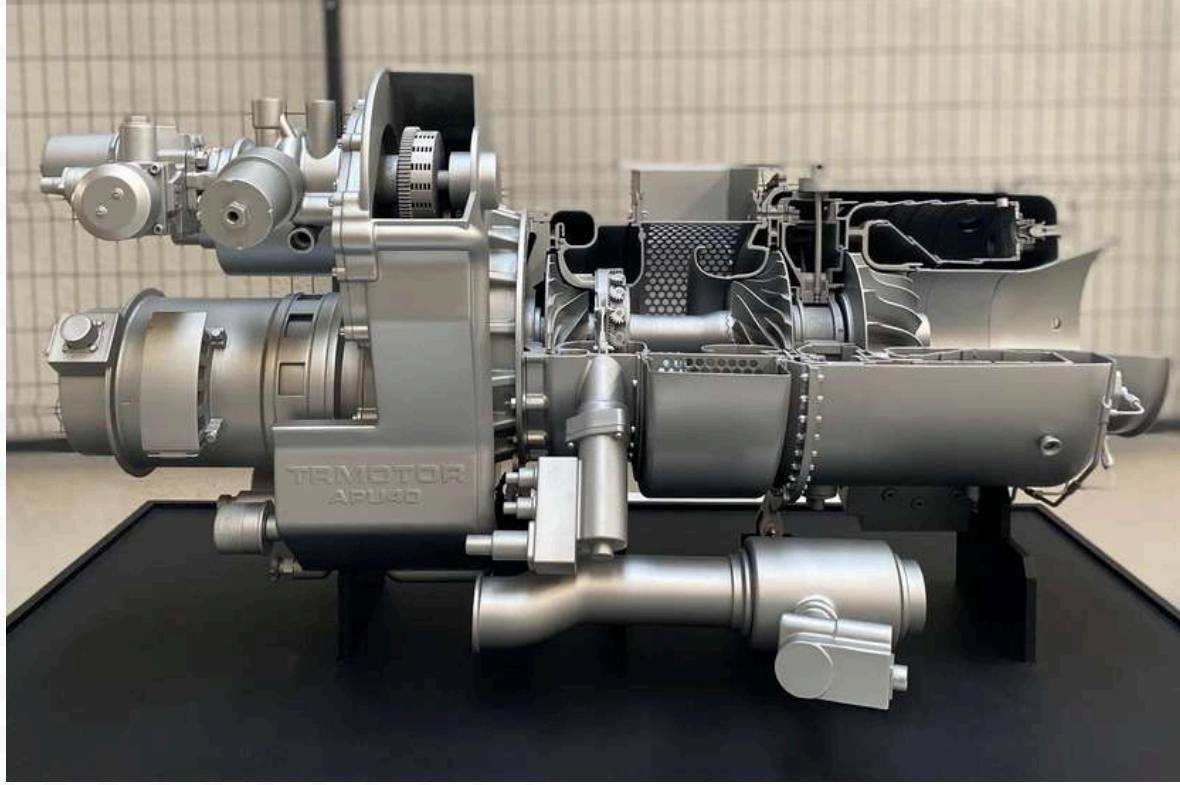

- DFAM çalışması
- Parçalı Üretim için özel kesim teknikleri
- Eklemeli İmalat ile üretim
- Ardıl İşlem ve Boya
- 1:1 Ölçek



TR Motor - APU 40 Motoru Mock-Up

## Büyük Kamyon Tarama ve Maket Üretimi



- 8 m uzunlukta kamyon 3B Tarama
- Tarama Süresi: 5 saat
- $\pm 0,1$  Hassasiyet
- DFAM
- Eklemeli İmalat ile Üretim
- Yüzey İşlem ve Boyama
- Montaj



Tarama ve Modelleme

İmalat

TFS Akaryakıt

# Başarı Hikayelerimiz - Tüketici Ürünleri



OTOMOTİV



SAĞLIK



MİMARİ



TÜKETİCİ ÜRÜNLERİ



SAVUNMA



HAVACILIK



EĞİTİM



ELEKTRONİK

## Az Adetli Fonksiyonel Prototip



- Endüstriyel Tasarım
- Seri İmalata Uygun Mekanik Tasarım
- Hızlı Kalıplama İle İmalat
- Yüzey İşlem ve Boya
- % 50 daha ekonomik, % 400 daha hızlı proje yönetimi

ÜRGE Projesi: POS Cihazı Tasarım ve Üretimi

# Başarı Hikayelerimiz - Sağlık



OTOMOTİV



SAĞLIK



MİMARİ



TÜKETİCİ ÜRÜNLERİ



SAVUNMA



HAVACILIK



EĞİTİM



ELEKTRONİK

## DENTAL - İmplant Tasarımı ve Üretimi

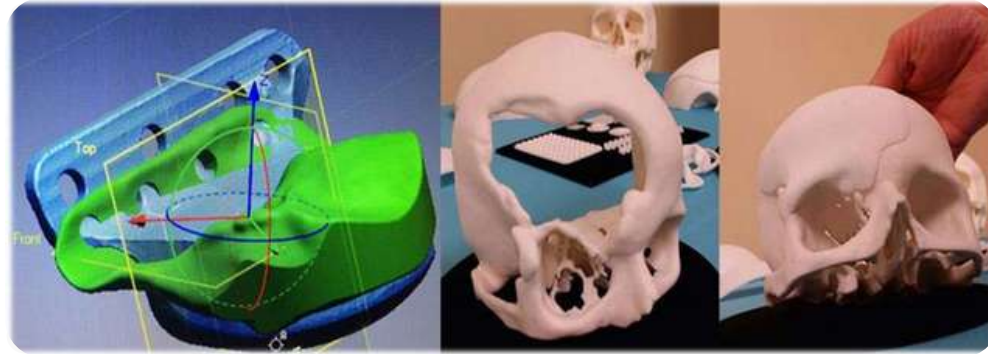

- 1 günde hızlı tasarım
- Her müşteriye özel tasarım
- 3D CT data ile çalışma
- Metal 3D printer ile titanyum baskı



- Ayakları olmayan martı için protez ayak üretimi
- 3D tarama ve tasarım
- Silikon kalıplama ile üretim

## ORTEZ & PROTEZ - Martı Protez Ayak



Global vizyonu olan bir  
mühendislik firmasıyız



Ortaklarımızla güçlü  
bağlar kurarız

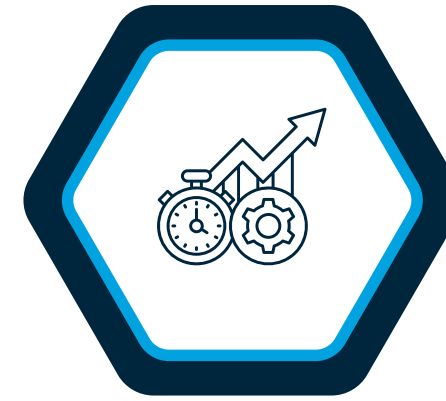

Sıkı çalışırız



Sıra dışı bir  
tedarikçiyiz



Yalnızca hizmetini  
verdiğimiz, güvendiğimiz  
ürünleri satarız



Çalışanlarımızı özenle  
seçeriz



3D teknolojileri adımız gibi  
biliriz



Biz ancak sizinle «BİZ»  
olabiliriz

# Bize Ulařın

## PLG Grup – İstanbul Ofis

Tatlısu Mah. řenol Güneř Bulvarı No: 2  
Mira Tower K:2 D: 12 Ümraniye - İSTANBUL

☎ 0 (216) 471 82 82

## PLG Grup – Bursa Ofis

Tahtalı Mah. Kiteyol Sok. No: 24  
Nilüfer – BURSA

☎ 0 (224) 441 14 82

## PLG Grup – Ankara Temsilcilięi

☎ 0 (542) 354 4994



[www.poligonmuhendislik.com](http://www.poligonmuhendislik.com)



[info@poligonmuhendislik.com](mailto:info@poligonmuhendislik.com)



**PLG Grup ile  
Yarına Liderlik  
Etmeye Hazır Ol!**

